

Modifications to a 2008 Ski-Doo Rev-XP MXZ x 600 HO SDI to Compete in the Clean Snowmobile Challenge 2008

Tony Ryan, Luke Korzeniewski, Wes Skaar, Ryan Kubat, Eric Murrock, Ryan Nell, Jason Junk, Hunter Hitzemann
Dan Hribar, Mike Kartchner
SAE Student Members, University of Wisconsin Platteville

Copyright © 2008 Society of Automotive Engineers, Inc.

ABSTRACT

A 2008 Ski-doo Rev-XP was redesigned to compete in the 2008 Clean Snowmobile Challenge. The objectives were to engineer a quiet, clean, and comfortable snowmobile while still maintaining OEM performance. Along with these important features the group also wanted to design a snowmobile that was rider, manufacturer, and environmentally friendly. While meeting these objectives, the performance characteristics that consumers have come to expect needed to be maintained or improved on the snowmobile. The University of Wisconsin-Platteville (UW-P) team modified the fuel system and engine to run on E-85 and incorporated a catalytic converter to reduce emissions output. The modifications on the snowmobile achieved UW-P's goals in a cost-effective manner, while maintaining reliability.

INTRODUCTION

The 2008 Clean Snowmobile Challenge is an engineering design competition for college and university student members of the Society of Automotive Engineers (SAE). It is organized and administered by SAE, and the Keweenaw Research Center (KRC).

The challenge is to modify a production snowmobile to improve emissions, reduce noise, while maintaining or improving the performance characteristics of the snowmobile. The modified snowmobile competes in the Clean Snowmobile Challenge starting March 10, 2008 in Houghton, Michigan. The competition consists of events including cold start, fuel economy, acceleration, handling, rider comfort, emissions, noise, and design. These events are spread over a six-day period [1].

The University of Wisconsin-Platteville SAE Clean Snowmobile team's overall objectives for the competition are to modify a snowmobile that:

- 1) Operates efficiently on E-85 fuel
- 2) Maintains or exceeds stock performance characteristics
- 3) Complete the competition with zero mechanical failures and safety issues
- 4) Compete for a top finish at the Clean Snowmobile Challenge 2008

TEAM BACKGROUND

The Clean Snowmobile Team Figure is one of several student design and competition teams within the SAE student chapter at UW-P. The project is managed and directed by the students, with the assistance of an advisor and the Department of Mechanical Engineering. The team is funded through the Segregated University Fee Allocation Commission (SUFAC), team fundraising, and commercial sponsors.



Figure 1: 2008 Clean Snowmobile Team

DESIGN STRATEGY

The UW-P Clean Snowmobile Team's intent was to modify a snowmobile to provide a successful entry in the 2008 Clean Snowmobile Challenge. The team has set out to meet the competition requirements for sound and emissions as well as maintaining the qualities desired in a production snowmobile by today's consumer standards.

Design constraints and criteria relevant to the modifications made to the snowmobile are outlined in the report to follow. A complete set of the constraints and criteria are provided in the Clean Snowmobile Challenge competition rules [1].

DESIGN CONSTRAINTS [1]

- ◆ Modifications to the engine, including substitution of a different engine is allowed. Two-stroke, four-stroke, and rotary engines are allowed. Engine displacement is limited to 600 cc or less for two-stroke and rotary engines, 960 cc or less for four-stroke engines.

- ◆ Snowmobiles must be fueled with E85 (nominally 85% ethanol and 15% premium gasoline). Refer to ASTM D5798-99 Standard Specifications for Fuel Ethanol for Automotive Spark Ignition Engines. Class 3 will be used at the Challenge (70% Ethanol). Note that E85 winter blend usually is blended with 70% to 79% ethanol to improve starting and running in the cold weather. All references to E85 in the rules imply winter blend E85 Class 3.
- ◆ The snowmobile must be propelled with a variable ratio belt transmission.
- ◆ The modified snowmobile must also meet or exceed all applicable safety standards
- ◆ The snowmobile's track may be replaced with a different track. The track must be a commercially available, one piece, molded rubber snowmobile track and cannot be modified.
- ◆ Ski and front suspension may be modified. However the snowmobile must remain ski steered, have at least six inches of suspension travel
- ◆ The use of traction control devices such as ice grousers, or paddles is not allowed; however, studs are allowed.

The team's first major decision was the use of a two-stroke engine because of the existing consumer confidence and the performance qualities of this engine. This engine selection meets our design criteria and goals. Strategy then focused on increasing the efficiency and power of the engine. Careful consideration was given to assure that these modifications did not exceed limitations set for emissions, noise, reliability and safety.

SAFETY

This year the UWP team considered safety as its most important goal. All of the safety regulations set by competition officials were met or exceeded on this year's snowmobile. Areas of focus were: thermal issues, clutch guard, battery box, carbides and studs.

A focus for this year was correcting the causes of the unexpected fire during last year's endurance event. The root cause of the fire was agreed to be excess exhaust heat produced by the catalytic converter under the hood. The extreme temperature of the catalytic converter and the lack of space in the Rev-XP chassis lead to the decision to externally locate the catalytic converter. Placing the catalytic converter outside the chassis will reduce the heat that it transfers to its surroundings due to the cooling from air and snow. Also, a heat shield has been designed out of metals to help dissipate heat away from the running board from which the catalyst is mounted. The combinations of these will in turn eliminate the chance of any thermal events. A thermal imaging camera has been used in the testing stages for the stock snowmobile and will be compared with that of the catalytic converter set up. This testing has been done in an effort to foresee any thermal problems that may be faced before completion arrives.

The clutch guard was constructed of 0.125 inch T6 aluminum and the underside was coated with a rubberized coating to minimize clutch noise and clutch guard vibration. The clutch guard was also lined with 18 inches of Kevlar belting.

To improve stopping capabilities, overall traction and handling, 96-1.375" Stud Boy® trail studs were used along with Ski-Doo® Pilot 5.7 skis with dual 6" carbides.

The non-conductive battery box was produced on a rapid prototype machine. This material is a thermoset plastic with increased strength and rigidity with an epoxy coating. The battery box was designed with safety in mind to minimize possibility of any arcing issues. The battery box insulates and protects both terminals from any outside contact. The SolidWorks drawing that was used to produce this part by the rapid prototyping machine can be seen in the Figure 2 below.

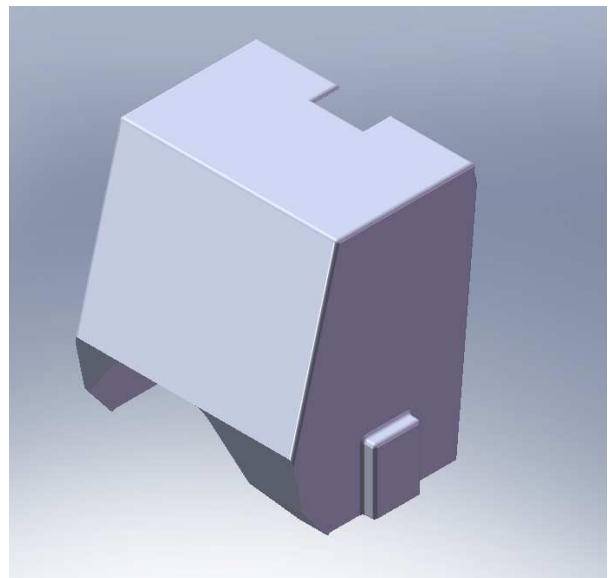

Figure 2: Plastic Rapid Prototyped Battery Box

A longer snow flap has been used to benefit two areas. The first of which is safety for the rider and riders who may follow. With the addition of studs there is more snow that sticks to the track and flies off the track when it makes a rotation. The longer snow flap will stop any debris that might fly towards another rider or the driver themselves. The second benefit would be cooling of the heat exchangers. When more snow is staying in the tunnel area, the more heat transfer between the snow and heat exchangers for optimal cooling.

NOISE REDUCTION

With noise pollution issues being one of the main focuses of the competition, noise was a primary concern for this year's snowmobile. After a weak performance in the noise event in the past, the noise reduction on the snowmobile is one of our primary design issues. There are several areas of concentrated noise production. These include clutch, exhaust, drive train noise as well as the potential of noise from the addition of battery box. To reduce the total amount of noise emitted, each

source of noise was individually evaluated and the best solution was determined for each case.

Base line sound level readings were first taken to determine the levels of noise from the new Ski-Doo® XP chassis and 600 SDI motor. The snowmobile performed remarkably well from 50 feet away with a pass at full acceleration. The average of the overall test results can be seen in Figure 3 below.

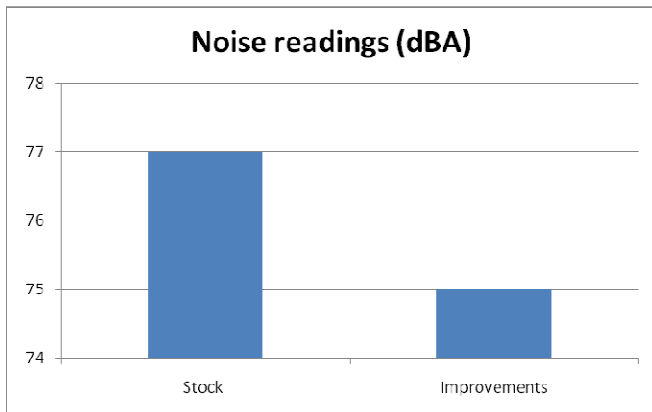

Figure 3: Noise Improvements

EXHAUST NOISE REDUCTION

One of the significant sources of noise on a two-stroke snowmobile is the exhaust system. Exhaust noise is created from the pressure pulses exiting from the exhaust ports and resonating through the exhaust system. The pressure and flow rate of air through the exhaust system creates a large source of noise. The sound level testing that was done on the stock set up proved that Ski-Doo® has designed a sufficient sound canceling exhaust system. Also, there have been many failed attempts in the past at altering the stock exhaust and using aftermarket systems. These alterations have led to problems with catalysts plugging up and not working due to the muffler packing dislodging. Other modifications have caused hot spots ultimately resulting in a fire. Aftermarket systems have resulted in somewhat louder than stock sound readings. The catalyst that is yet to be tested has been designed to reduce exhaust noise. A turn down exit with an angled cut has been designed for optimum sound deadening. A large diameter exit pipe was also designed to create a deeper sound rather than the higher pitch sound that a smaller pipe diameter would cause. This deeper sound is far friendlier to the human ear than is a higher pitch sound. [5]

CHASSIS NOISE REDUCTION

In the past, sound dampening material has been used to try and contain the entire engine compartment. This however has proven not cost effective. The material has helped with lowering noise, but the costs including both the relatively high dollar cost, as well as the cost of the added weight have shown to not be cost effective. With this in mind, dampening materials have been localized around the concentrated noise

source. This approach was used to deaden the most troublesome noise contributors while still maintaining the rider comfort of a light snowmobile.

Such opportunities to reduce noise were presented when looking at the design of the clutch guard. Since a variable ratio belt transmission is required by competition rules, noise emitted from the clutches created a unique problem. As the clutch engages and disengages, the driveline creates high frequency noise. Air disturbance caused by the high RPM of the clutches is a major cause of noise emissions. Since the use of a variable ratio belt transmission could not be avoided, the noise it creates must be absorbed by the sound material that lines the clutch guard. The clutch guard must fully contain and cover the clutches for safety, which also offers some help with containing clutch and belt noise. To further reduce the noise from this area, the inside of the clutch guard is designed with a sound absorbing spray rubber coating. This works in two ways, first it helps deaden the noise being transmitted through the clutch guard, and finally it helps deaden the vibrations of the clutch guard itself caused by the engine. These engine initiated vibrations can ultimately cause rattles between the guard and its surroundings if not properly dampened.

The battery box was also designed to be made out of a plastic material through the use of a rapid prototyping machine. This area is not a direct cause of noise, but the addition of an aluminum battery containment box will cause unwanted vibrations, therefore generating noise. This rapid prototyped battery box was designed for minimum material while still having the structural integrity that is needed, resulting in a part that is lighter than if it were constructed with other materials. This light and compact battery box can be seen above in Figure 2.

Another source of noise is the interaction of the idler wheels and the track. As the snowmobile moves, the idler wheels found on the skid frame roll over the inner surface of the track. On a conventional snowmobile track, idler wheels receive an impact load from the lugs and fiberglass reinforcing rods molded in the track. This loading scenario creates a distinctive sound frequency that can be reduced or removed by removing excess idler wheels. A tradeoff to removing idler wheels is increased wear on the slides when encountering marginal snow conditions. To offset this, Hiperfax® slides were used on the skid frame as previously mentioned.

POWERTRAIN

Choice of engine plays a large role in the design strategy. Both the two-stroke engine and the use of a four-stroke engine were equally considered. For many, the four-stroke engine is the first choice because of the lower emissions. This is a common reaction because the four-stroke cycle controls the exhausting of combustion gases and the induction of the fresh air/fuel charge more efficiently than that of the two-stroke. However, the four-stroke engine has a lower power to weight ratio when compared to a two-stroke. Newly designed two-strokes have proven to have the potential to produce excellent fuel mileages as shown below in Figure 4. [13]

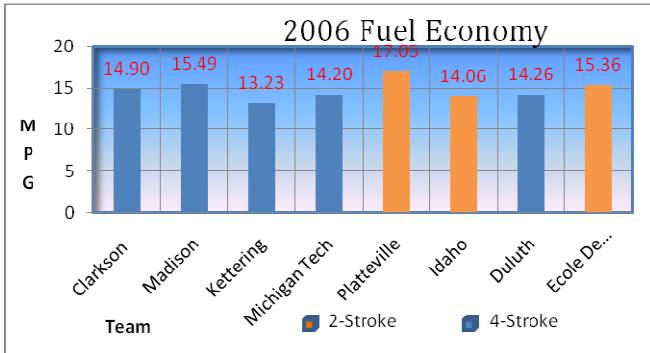

Figure 4: Past Competition Fuel Economy

A two-stroke semi-direct injected (SDI) engine was chosen over an ordinary carbureted two stroke engine because of its superior emissions, performance, fuel economy, and reliability. Another reason the SDI was chosen was because of the ability to use an aftermarket fuel controller to precisely modify the fuel delivery to accommodate E-85. Electronic injected engines are the future of the snowmobile industry. They incorporate both the power and weight characteristics of two-strokes with the low emissions and low noise levels of four-strokes. These qualities along with the proven reliability of the Rotax 2-Tec SDI 600cc engine; have resulted in this engine to be our 2008 competition engine of choice. [10]

FUEL SYSTEM

A requirement of this year's competitions is to have the snowmobile run on E85 fuel. Running E85 meant an entire fuel system conversion. Ethanol requires roughly a 30% increase in the amount of fuel to air compared to gasoline. This is due to the fact that ethanol contains about 30% less energy than that of gasoline. This additional fuel is accomplished through an increased pulse duration and intensity of the injectors. After compiling the previous year's knowledge with additional research the team decided that the best and most effective way to calibrate the fuel delivery system was to use a Boondocker® EFI fuel management system. The Boondocker® control box allows fuel adjustment in seven different RPM ranges as well as low, mid, and high throttle positions. [12] A five button interface allows for programming adjustments without the use of any additional hardware. The Boondocker® control box is relatively inexpensive in comparison to other fuel management systems and is far more user friendly. The simple controls of this system can be seen in Figure 5 below.



Figure 5: Boondocker® EFI fuel management system. [12]

THE ENGINE

Our Rotax® 2-Tec Semi Direct Injected (SDI), seen in Figure 6, utilizes a 72mm bore, 73mm stroke, and 46mm throttle bodies to provide optimum performance within the 600cc displacement limit for 2-strokes. The Rotax® 2-Tec SDI engine excels in many areas of the 2008 Clean Snowmobile Challenge. The SDI engine delivers a 50% decrease in emissions and a 25% increase in fuel efficiency compared to a carbureted two stroke engine. The 594.4cc motor uses two injectors in each of the two cylinders to deliver the correct amount of fuel into the transfer ports to maintain a Stoichiometric mixture. The SDI engine can easily reduce fuel flow at idle or low speeds by only operating one injector per cylinder. When the snowmobile is running at high speed the electronic control module (ECM) activates the second injector. Along with controlling the injectors, the ECM examines the incoming data including the crank position, atmospheric pressure, throttle position, ambient temperature, engine knock, and the engine temperature. It uses this information to adjust timing, injection rates, and exhaust valve movement. All of this information is computed by the ECM to provide a response to the drivers input providing sufficient performance as well as better fuel economy and emissions. [10]



Figure 6: Rotax 2-Tec SDI 600 engine [10]

Several engine modifications were made to better accommodate the E-85 fuel which included: RK-Tech® head, nickel silicon carbide composite coating on cylinders, and RK-Tech® dual ring pistons. The RK-Tech® head allows for the combustion domes to be switched out as can be seen in Figure 7. The RK-Tech domes have several cut designs that allowed for different fuel efficiencies, compression ratios, and horsepower ratings. We compared two sets of these custom cut domes on 93 octane pump gas. As seen in Figure 8, a traditional polished dome was used resulting in fuel mileage of 15.55 mpg. The radial ribbed design seen in Figure 9 resulted in 17.98 mpg. This small design change resulted in a 15.6% increase in fuel economy as you can see in Figure 10. Therefore the domes to be used for E-85 are the radial ribbed domes cut to a different compression ratio for E-85. The 93 octane pump gas domes have a compression ratio of 13.2:1,

and the E-85 domes have a compression ratio of 14.1:1. The higher compression ratio allows for better utilization of the comparable octane rating of 110 in E-85 fuel.

This cylinder head is made of 7075 T6 aluminum which is more rigid due to its overall superior strength than the conventional 6061 aluminum used. The nickel silicon carbide composite coating increased wear resistance of the cylinder walls and the RK-Tech® dual ring pistons transfer heat from the pistons to the cylinder walls which reduce ring flaking. [7]

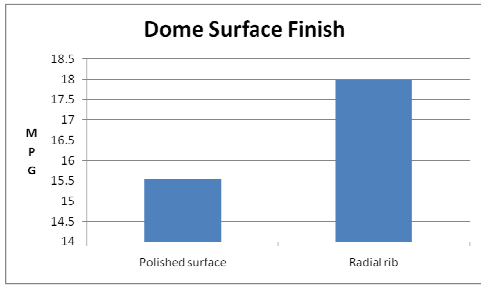

Figure 10: Dome Surface Finish Compared to MPG

CLUTCHING

A large factor in driveline efficiency with a variable ratio belt transmission is tuning of the clutches to efficiently transmit maximum power to the track.



Figure 7: RK-Tech head with changeable combustion domes

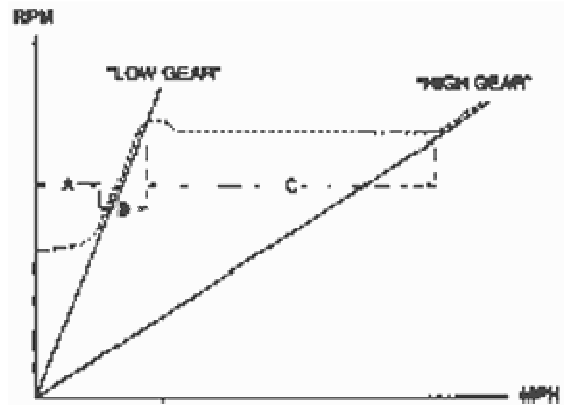

Figure 11: Properly Tuned Clutches (MPH vs. RPM) [3]

The first thing that must be considered in clutch tuning is the engagement speed shown as segment A in Figure 11. The engagement speed should be at the lowest speed possible without creating an engine bog. If the engagement speed is set too high, damage to drive components can occur and controlling the snowmobile can be very difficult. OEM Skidoo® Summit clutch ramps are being implemented over stock trail ramps in our primary clutch. This enables smoother engagement while lowering the engagement rpm. The secondary clutch uses a steeper initial angle on the helix, which causes the secondary clutch to reach full-shift-out sooner. This allows for a higher top speed while lowering cruising engine rpm. The lowering of the cruising rpm allows for improved fuel mileage. These two segments must be set properly in order to achieve the quickest acceleration. Segment B in Figure 11 is the low gear acceleration, and segment C the up shifting acceleration.

The most important aspect of clutch tuning is controlling the engine speed so that it coincides with the rpm's, at which the engine is the most efficient while creating the best horsepower, emissions, and fuel millage. With a two-stroke engine, this maximum horsepower occurs over a very short range of rpm's. In order for the engine to remain running in this range, the weights and springs on the primary clutch must be adjusted. Along with adjusting the primary clutch, the



Figure 8: Traditional Polished Surface Finish.

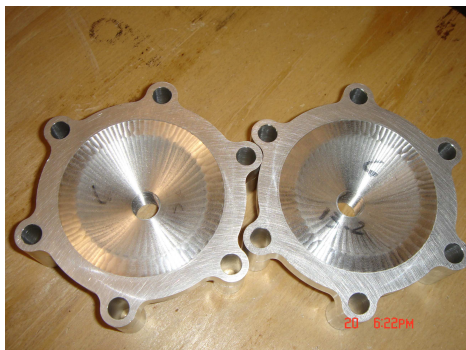

Figure 9: Radial Ribbed Surface Finish.

spring and cam angle on the secondary clutch must also be adjusted to keep the engine operating at its maximum efficiency through the entire acceleration run. [3]

REAR SKID FRAME

The Ski-doo® SC-5 suspension features the use of aftermarket slides. These Hiperfax® slides utilize Teflon® inserts that improve driveline performance by reducing friction between the rails of the skid frame and the track. As the snowmobile is driven, the Teflon® coating is spread onto the track clips in order to create a Teflon®-to-Teflon® contact area. While most slides have a melting point near 300°F, Hiperfax® slides have a melting point close to 700°F. By increasing the melting point of the slides, the chance of the slides approaching these temperatures under poor trail conditions is greatly reduced. If the slides approach their melting temperature they will increase the kinetic friction between them and the track, therefore greatly reducing driveline efficiency. Gains in fuel economy of three to four miles per gallon have been seen, according to the manufacturer. These gains in fuel economy are due to the decreased friction in the track-slide interface. Hiperfax® slides, along with properly tuned clutches allow the snowmobile to achieve improved fuel mileage while still maintaining OEM performance. [4]

The flow of snow and air into and out of the skid was improved with the addition of Slydog® wheels. They have incorporated a fan blade into their design to propel the air as seen in Figure 12 below. The fan blade design improves the cooling of the Hiperfax® by having the front wheels circulate air and snow into the skid. The rear wheels are designed to expel snow and air from the rear skid to help eliminate snow and ice build-up. The Slydog® wheels are also lighter than the OEM wheels helping reduce the amount of rotating mass in the skid consequently reducing the amount of drag on the driveline. [14]



Figure 12: Slydog® Fan Blade Design [14]

EMISSIONS

One main area of concern in preparing for the 2008 Clean Snowmobile Challenge was the exhaust system. This system

has a huge effect on both the noise level of the snowmobile as well as the emissions. Since these two criteria are weighted the heaviest at competition, the exhaust system was given special attention. As stated earlier, initial noise testing was done and proved that the stock exhaust was sufficient to meet noise requirements. Initial emissions data was also collected. This data however was later found to have an error due to an exhaust leak.

THE EXHAUST

Knowing that our data had been skewed, better emissions were targeted through the use of a catalytic converter. This catalyst was designed with several design restraints. These included the requirement of better emissions, reduced noise, heat insulation and dissipation, as well as a size and shape constraint.

CATALYTIC CONVERTER

The purpose of the catalyst is to convert hydrocarbons (HC), carbon monoxide (CO), and nitrogen oxide (NO_x) into water, carbon dioxide (CO₂) and hydrogen (H). This process involves chemical reactions between the catalyst material and the exhaust entering the catalyst. The material on the surface that makes these conversions possible is: alumina oxide, cerium oxide, rare earth metal stabilizers, and the precious metals platinum, palladium and rhodium. [8]

A catalyst with a cell density of 400 cells per inch was selected for this year's competition. This design was used in order to meet the required flow rates and allow for enough surface area to complete the reactions. The catalyst uses a ceramic substrate, this allows for higher temperatures in the catalyst without the substrate failing.

With the use of the ceramic substrate there has to be an isolation layer between that and any metallic housing. This is necessary due to the fact that the steel housing and the ceramic substrate have different coefficients of thermal expansion. As the temperatures in the catalyst increase the steel expands at a quicker rate than the ceramic substrate. If these two were directly connected the stresses from this expansion could cause the substrate to crack.

For this layer a catalytic converter insulation material was used. This material is especially designed to have optimal mid to high temperature operation. Its purpose is to isolate the substrate from the housing and serve as an insulation to keep the housing temperatures lower. The housing was assembled using a tourniquet style wrap. This is one of the latest advancements in catalyst assembly technology. It assembles the housing and mat to a given pressure, which automatically makes up for any variations in the substrate and the mat material. This is all accomplished by closing to the housing to given pressure instead of a set dimension as with most catalyst assembly practices. This type of assembly allows the converter to withstand accelerations up to 75g for the entire life of the vehicle. The catalyst housing is made of stainless steel, 409 on the conical sections, and 441 for the remainder. The catalyst and housing can be seen in Figure 13 [6]

The catalyst used on the Rev-XP is divided into two separate substrate bricks, with secondary air injection between the two bricks. The first brick has a three-metal washcoat: platinum, rhodium, and palladium. This brick is designed to be an extremely effective at reducing NO_x as well as beginning the conversion of the other exhaust gases that are present. The second brick has a palladium and rhodium washcoat. This is used to clean up the emissions, effective on HC and CO emissions as well as finishing the NO_x conversion. Rhodium is the best of the precious metals to help in the conversion of all three major raw exhaust gases; therefore the second brick has an especially high concentration of rhodium. Rhodium is also the least costly of the precious metals used in catalytic converters. The basic layout and workings of the catalytic converter can be seen in. [6]



Figure 13: Catalytic Converter

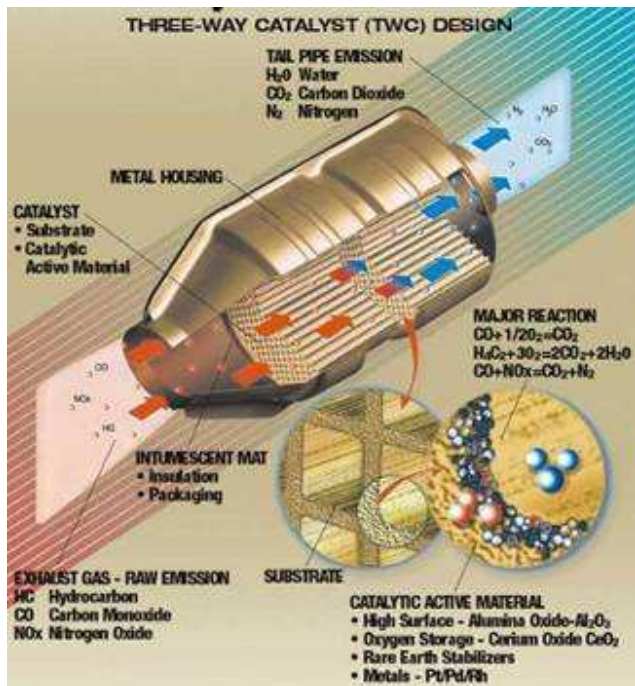

Figure 14: Structure and Function of a Catalytic Converter [2]

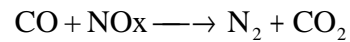
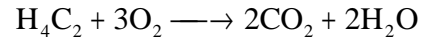
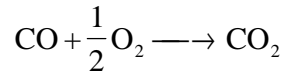

Figure 15: Typical Chemical Reactions in a Catalytic Converter

RIDER COMFORT

Realizing that last year's chassis, Polaris Pro X, was out of date as far as rider comfort the team decided to purchase a new chassis. After some research of current production snowmobile the Ski-doo Rev-XP was chosen for its superior ergonomics and suspension. The 2008 REV XP® chassis offers many new features over the 2007 REV® chassis. This design was created around a rider forward design. The concept is best described as if a person was to ride an ATV. This design allows longer ride time on the snowmobile. The idea behind this design is to keep the back aligned in a straight vertical position. This reduces the amount of stress and strain that one would endure riding all day. Typically a snowmobile will tend to rock back and forth as it hits bumps. The rider forward positioning allows the rider to be positioned near the center of the chassis, or the pivot point so a minimum rocking motion is felt by the rider. The rider forward position gives the rider a total of over 8 more inches of foot clearance. This allows the rider to be more comfortable by allowing the ride to move their feet and legs. Figures 12 and 13 compare the 2007 REV® versus the 2008 REV XP®. Another attribute to this design is the attention focused on weight reduction. This lighter sled allows the rider to use less force in order to maneuver the sled through tight corners. Two luxury items that make this snowmobile user friendly are electric start and reverse. Both of these items are controlled with the user's left hand interface controller. This controller uses simple push buttons to start the sled and put it into reverse. [10]



Figure 16: 2007 Ski-Doo REV® Chassis [10]

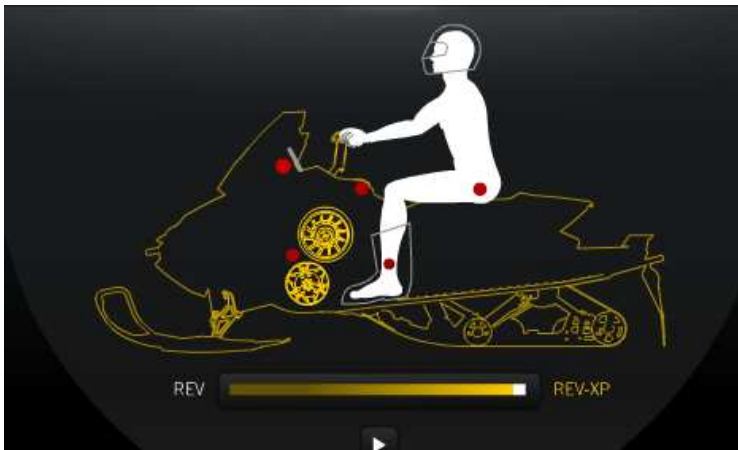

Figure 17: 2008 Ski-Doo REV-XP® chassis [10]

Weight

Overall snowmobile weight is a contributing factor to fuel economy, handling, and acceleration. All of these aspects contributed to in the decision to use a Skidoo Rev XP chassis. After mounting our 2004 Skidoo Rotax 600 SDI in the XP chassis it weighed in at 420lbs with reverse and electric start. After filling with E85, oil and the mounting the catalytic converter, the sled weighed in at 515lbs. This was a great improvement from last year's Polaris chassis which weighed 661 lbs. See Figure 18 for our 2008 weight vs. competitors from the past year's competition. [14]

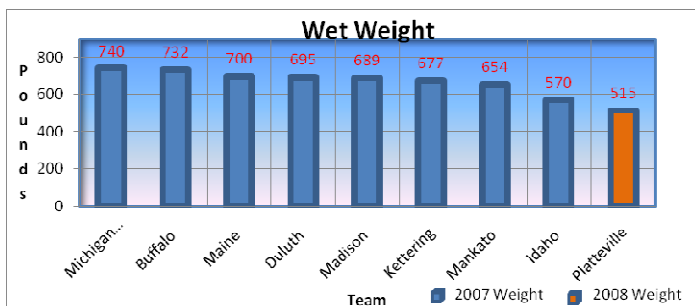

Figure 18: 2008 Weight VS. 2007 Competition

CONCLUSION

Modifying a 2008 Ski-doo Rev-XP 600 SDI for the 2008 SAE Clean Snowmobile Challenge presented many challenges to the UWP team. The goal was to produce a snowmobile that is both rider and environmentally friendly, as well as maintaining or improving performance characteristics. This has been accomplished in a cost effective manner that has not included extravagant new engineering that would lead to increasing manufacturing costs.

Team UWP is very confident in the design decisions made throughout the modification of the Rev-XP. This student team is certain that this snowmobile will meet or exceed all

expectations and regulations set by the 2008 SAE Clean Snowmobile Challenge. UWP believes that the modifications made to this Rev-XP are the keys to pleasing the general public by making snowmobiling both an environmentally friendly and exciting sport.

Acknowledgements

We would like to thank the following sponsors for making the project possible: RFA, University Of Wisconsin Platteville SUFAC, United Ethanol, United Corporate, Edgewater Marine, Skidoo "Gordy Radke", Rk-Tek, Amsoil, Boondocker, Digatron, Millennium Technologies, Motosports Factory, Slydog, Stud Boy, Hiperfax, Retrax, Kohn's Auto Body, Fastenal, Goodwin Performance, HMK, Land and Sea, Emission Systems, Signs-to-Go, Mechanical Engineering Dept., Electrical Engineering Dept, Thermal Imaging from Grant County Emergence Services.

References

- 2008 Rules Committee, The SAE Clean Snowmobile Challenge 2008 Rules. Warrendale, PA: The Society of Automotive Engineers (SAE). 2007
- OMG website, <http://www.autocatalyst-recycling.umicore.com/catalyticConverter/>
- Olav Aaen, Clutch Tuning Handbook. 1986
- Hiperfax, www.hiperfax.com. 2005
- Marco Nuti. Emissions From Two-Stroke Engines. Society of Automotive Engineers, Inc. 1998
- Midgley, Mark W. V-Converter Corp. 03/02/04
- RK TEK, website, www.2strokeheads.com
- Polymer Technology, Newark, DE. 2005
- Ski Doo, website, www.skidoo.com. 2007
- Heisler, Heinz. Vehicle and Engine Technology. 2nd edition, Society of Automotive Engineers, Inc. 1999
- Boondocker Performance, website, www.boondocker.com
- SlyDog, website, www.slydogskis.com
- Society of Automotive Engineers, Inc., The SAE Clean Snowmobile Challenge Results 2006.
- Society of Automotive Engineers, Inc., The SAE Clean Snowmobile Challenge Results 2007.